



Storm Plastics

MANUFACTURERS OF SPECIALISED PVC-U PLUMBING PRODUCTS

National Product Guide

The Most Flexible of all Swivels in the Market
The New Range of Swivel Expansion Combo Joints feature 100mm Movement Capacity to accommodate soil movement in M to E Class Soils as per AS 2870 Flexible Joint Requirements.

**NEW 100mm
Movement
DWV Swivel
Combo Joint**

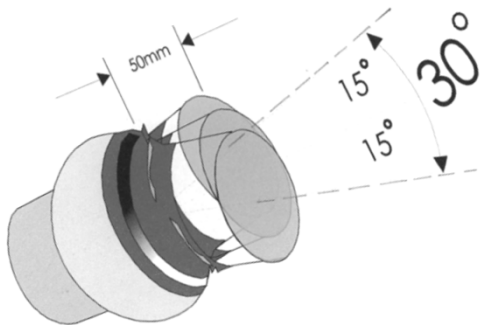

**Original Swivel Joint
with 50mm Movement,
Capable of 360° Rotation &
+/- 15° Angular Deflection.**

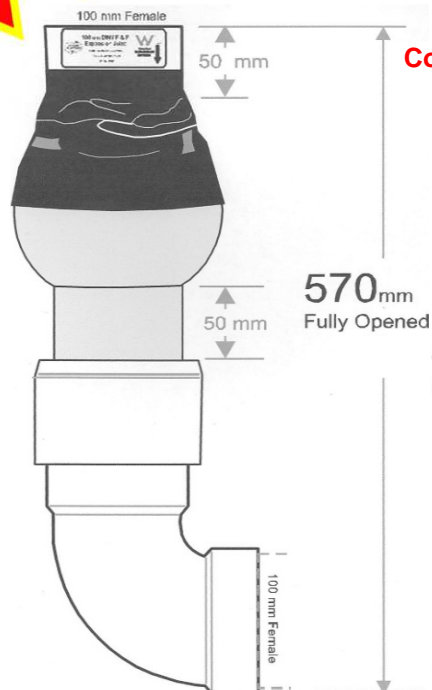

Code: **SJ100BendCombo**

Code: **SJ100ExpComboFM**
Code: **SJ100ExpComboFF**

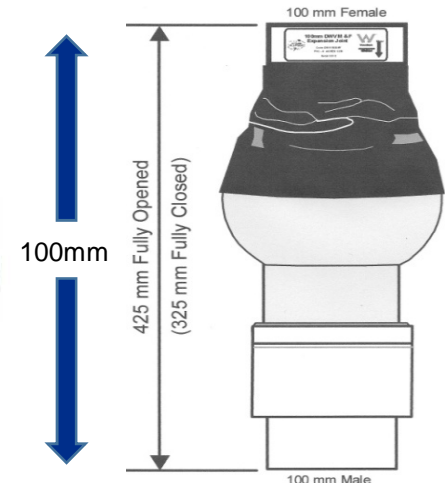
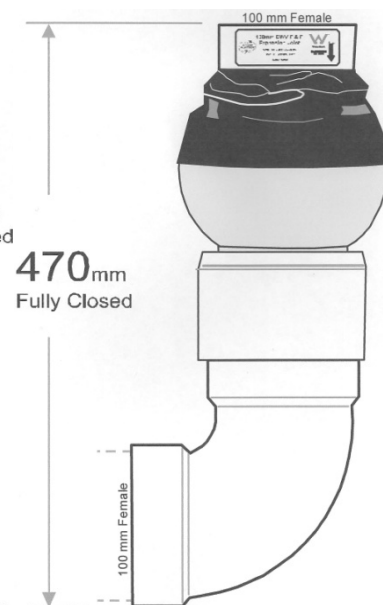

**Available with male spigot at
base of fitting to glue directly
into Junctions & Bends to
reduce overall height!**

Storm Plastics National Product Guide



4 Dunorlan Road
EDWARDSTOWN SA 5039
Ph: 08 83743277 Fax: 08 8374 3279
Email: info@stormplastics.com.au Website: www.stormplastics.com.au

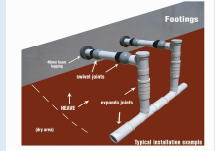

Product Photo	Product Code	Product Description	UOM	Barcaode #	EACH	Barcode	Carton Qty	Carton Dimensions
	B1502	150mm Silt Trap Bucket with 2mm holes PVC	EA	9349669000008	1	 9 349669 000008 B1502	1	N/A
	B1503	150mm Silt Trap Bucket with 3mm holes PVC	EA	9349669001449	1	 9 349669 001449 B1503	1	N/A
	B1505	150mm Silt Trap Bucket with 5mm holes PVC	EA	9349669001456	1	 9 349669 001456 B1505	1	N/A
	B150SS1.5	150mm Stainless Steel Bucket with 1.5mm holes to suit 150mm PVC Silt Trap	EA	9349669000015	1	 9 349669 000015 B150SS1.5	1	N/A
	B160SS1.5HDPE	160mm Stainless Steel Bucket with 1.5mm holes to suit 160mm HDPE Silt Trap	EA	9349669000022	1	 9 349669 000022 B160SS1.5HDPE	1	N/A
	B2252	225mm Silt Trap Bucket with 2mm holes PVC	EA	9349669000039	1	 9 349669 000039 B2252	1	N/A
	B2253	225mm Silt Trap Bucket with 3mm holes PVC	EA	9349669001463	1	 9 349669 001463 B2253	1	N/A
	B2255	225mm Silt Trap Bucket with 5mm holes PVC	EA	9349669001470	1	 9 349669 001470 B2255	1	N/A

*Note: For all Expansion and Swivel Joints - FF = Female socket to Female socket FM = Female socket to Male pipe size

MF = Male pipe size to Female socket

MM= Male pipe size to Male pipe size

Storm Plastics National Product Guide

Prices are nett and do not include GST

Product Photo	Product Code	Product Description	UOM	Barcaode #	EACH	Barcode	Carton Qty	Carton Dimensions
	B225SS1.5	225mm Silt Trap Bucket Stainless Steel with 1.5mm holes to suit 225mm PVC Silt Trap	EA	9349669000046	1	 9 349669 000046 B225SS1.5	1	N/A
	B250SS1.5HDPE	250mm Silt Trap Bucket Stainless Steel with 1.5 mm holes to suit HDPE Silt Trap	EA	9349669000053	1	 9 349669 000053 B250SS1.5HDPE	1	N/A
	DP100100100	100mm x 100mm x 100mm Downpipe Adaptor PVC	EA	9349669000060	1	 9 349669 000060 DP100100100	1	N/A
	DP10012595	100mm x 125mm x 95mm Downpipe Adaptor PVC	EA	9349669000077	1	 9 349669 000077 DP10012595	1	N/A
	DP100130	100mm x 130mm Round Downpipe Adaptor x 200mm Long PVC	EA	9349669000084	1	 9 349669 000084 DP100130	1	N/A
	DP10072127	100mm x 72mm x 127mm Downpipe Adaptor PVC	EA	9349669000091	1	 9 349669 000091 DP10072127	1	N/A
	DP10075155	100mm x 75mm x 155mm Downpipe Adaptor PVC	EA	9349669000107	1	 9 349669 000107 DP10075155	1	N/A
	DP10080100FB	100mm x 80mm x 100mm Flat Back Downpipe Adaptor PVC	EA	9349669000114	1	 9 349669 000114 DP10080100FB	1	N/A
	DP10085100	100mm x 85mm x 100mm Downpipe Adaptor PVC	EA	9349669000121	1	 9 349669 000121 DP10085100	1	N/A

*Note: For all Expansion and Swivel Joints - FF = Female socket to Female socket FM = Female socket to Male pipe size

MF = Male pipe size to Female socket MM= Male pipe size to Male pipe size

Storm Plastics National Product Guide

Prices are nett and do not include GST

Product Photo	Product Code	Product Description	UOM	Barcaode #	EACH	Barcode	Carton Qty	Carton Dimensions
	DP150100230	150mm x 100mm x 230mm Downpipe Adaptor PVC	EA	9349669000138	1	 9 349669 000138 DP150100230	1	N/A
	DP150105155	150mm x 105mm x 155mm Downpipe Adaptor PVC	EA	9349669000145	1	 9 349669 000145 DP150105155	1	N/A
	DP150105185	150mm x 105mm x 185mm Downpipe Adaptor PVC	EA	9349669000152	1	 9 349669 000152 DP150105185	1	N/A
	DP150105205	150mm x 105mm x 205mm Downpipe Adaptor PVC	EA	9349669000169	1	 9 349669 000169 DP150105205	1	N/A
	DP150115230	150mm x 115mm x 230mm Downpipe Adaptor PVC	EA	9349669000176	1	 9 349669 000176 DP150115230	1	N/A
	DP150115270	150mm x 115mm x 270mm Downpipe Adaptor PVC	EA	9349669000183	1	 9 349669 000183 DP150115270	1	N/A
	DP150125125	150mm x 125mm x 125mm Downpipe Adaptor PVC	EA	9349669000190	1	 9 349669 000190 DP150125125	1	N/A
	DP150125175	150mm x 125mm x 175mm Downpipe Adaptor PVC	EA	9349669000206	1	 9 349669 000206 DP150125175	1	N/A
	DP150150150	150mm x 150mm x150mm Downpipe Adaptor PVC	EA	9349669000213	1	 9 349669 000213 DP150150150	1	N/A
	DP150395165	150mm x 395mm x 165mm Fabricated Downpipe Adaptor PVC	EA	9349669000220	1	 9 349669 000220 DP150395165	1	N/A

*Note: For all Expansion and Swivel Joints - FF = Female socket to Female socket FM = Female socket to Male pipe size

MF = Male pipe size to Female socket

MM= Male pipe size to Male pipe size

Storm Plastics National Product Guide

Prices are nett and do not include GST

Product Photo	Product Code	Product Description	UOM	Barcaode #	EACH	Barcode	Carton Qty	Carton Dimensions
	DP15080230	150mm x 80mm x 230mm Fabricated Downpipe Adaptor PVC	EA	9349669000237	1	 9 349669 000237 DP15080230	1	N/A
	DP200100100	200mm x 100mm x 100mm Fabricated Down Pipe Adaptor PVC	EA	9349669000244	1	 9 349669 000244 DP200100100	1	N/A
	DP225205205	225mm x 205mm x 205mm Downpipe Adaptor PVC - With Socket opposite end	EA	9349669000251	1	 9 349669 000251 DP225205205	1	N/A
	DP225305150	225mm x 305mm x 150mm Downpipe Adaptor PVC - With Socket opposite end	EA	9349669000268	1	 9 349669 000268 DP225305150	1	N/A
	DP908585	90mm x 85mm x 85mm Downpipe Adaptor PVC	EA	9349669000275	1	 9 349669 000275 DP908585	1	N/A
	DSJ/EXTEJ100	100mm DWV F&M Double Swivel Joint/Extended Expansion Joint PVC. Allows +/- 15° rotation either end. Made to order as per customer's requirements	EA	9349669000282	1	 9 349669 000282 DSJ/EXTEJ100	1	N/A
	DW100100FF	100mm DWV F&F Expansion Joint PVC. Allows approximately 100mm movement. Fitting measures 365mm open 265mm closed	EA	9349669000299	1	 9 349669 000299 DW100100FF	12	530 x 400 x 350

*Note: For all Expansion and Swivel Joints - FF = Female socket to Female socket FM = Female socket to Male pipe size

MF = Male pipe size to Female socket

MM= Male pipe size to Male pipe size

Storm Plastics National Product Guide

Prices are nett and do not include GST

Product Photo	Product Code	Product Description	UOM	Barcaode #	EACH	Barcode	Carton Qty	Carton Dimensions
	DW100100FM	100mm DWV F&M Expansion Joint PVC. Allows approximately 100mm movement. Fitting measures 365mm open 265mm closed	EA	9349669000305	1	 9 349669 000305 DW100100FM	12	530 x 400 x 350
	DW100100MF	100mm DWV M&F Expansion Joint PVC. Allows approximately 100mm movement. Fitting measures 365mm open 265mm closed	EA	9349669000312	1	 9 349669 000312 DW100100MF	12	530 x 400 x 350
	DW100100MM	100mm DWV M&M Expansion Joint PVC. Allows approximately 100mm movement. Fitting measures 365mm open 265mm closed	EA	9349669000329	1	 9 349669 000329 DW100100MM	12	530 x 400 x 350
	DW100100SST	100mm DWV M&F Special Short Taped Expanda Joint PVC (Taped with Expanda Tape). Allows approximately 100mm movement. Fitting measures 370mm open 270mm	EA	9349669000336	1	 9 349669 000336 DW100100SST	12	530 x 400 x 350
	DW100150	100mm DWV M&F Expanda Joint PVC. Allows approximately 150mm movement. Fitting measures 470mm open 320mm closed	EA	9349669000343	1	 9 349669 000343 DW100150	12	530 x 400 x 350
	DW100150C	100mm DWV F&F Expanda Coupling PVC HDPE Compatible. Fitting measures 265mm. Allows approximately 150mm movement	EA	9349669000350	1	 9 349669 000350 DW100150C	12	530 x 400 x 350
	DW100150CFM	100mm DWV F&M Expanda Coupling PVC, HDPE Compatible. Rubber ring one end, solvent weld joint on other end. Allows approx. 150mm movement Measures 250mm	EA	9349669001418	1	 9 349669 001418 DW100150CFM	12	530 x 400 x 350

*Note: For all Expansion and Swivel Joints - FF = Female socket to Female socket FM = Female socket to Male pipe size

MF = Male pipe size to Female socket MM= Male pipe size to Male pipe size

Storm Plastics National Product Guide

Prices are nett and do not include GST

Product Photo	Product Code	Product Description	UOM	Barcaode #	EACH	Barcode	Carton Qty	Carton Dimensions
	DW100150FF	100mm DWV F&F Expansion Joint PVC. Allows approximately 150mm movement. Fitting measures 455mm open 305mm closed	EA	9349669000367	1	 9 349669 000367 DW100150FF	12	530 x 400 x 350
	DW100150FM	100mm DWV F&M Expansion Joint PVC. Allows approximately 150mm movement. Fitting measures 455mm open 305mm closed	EA	9349669000374	1	 9 349669 000374 DW100150FM	12	530 x 400 x 350
	DW100150MM	100mm DWV M&M Expansion Joint PVC. Allows approximately 150mm movement. Fitting measures 460mm open 310mm closed	EA	9349669000381	1	 9 349669 000381 DW100150MM	12	530 x 400 x 350
	DW100150T	100mm DWV M&F Expanda Joint Taped PVC (Taped with Expanda Tape). Allows approximately 150mm movement Fitting measures 380mm	EA	9349669000398	1	 9 349669 000398 DW100150T	12	530 x 400 x 350
	DW100220FF	100mm DWV F&F Expansion Joint PVC. Allows approximately 220mm movement. Fitting measures 595mm open 375mm closed	EA	9349669000404	1	 9 349669 000404 DW100220FF	8	470 x 320 x 560
	DW100220FM	100mm DWV F&M Expansion Joint PVC. Allows approximately 220mm movement. Fitting measures 595mm open 375mm closed	EA	9349669000411	1	 9 349669 000411 DW100220FM	8	470 x 320 x 560

*Note: For all Expansion and Swivel Joints - FF = Female socket to Female socket FM = Female socket to Male pipe size

MF = Male pipe size to Female socket

MM= Male pipe size to Male pipe size

Storm Plastics National Product Guide

Prices are nett and do not include GST

Product Photo	Product Code	Product Description	UOM	Barcode #	EACH	Barcode	Carton Qty	Carton Dimensions
	DW100220MF	100mm DWV M&F Expansion Joint PVC. Allows approximately 220mm movement. Fitting measures 595mm open 375mm closed	EA	9349669000428	1	 9 349669 000428 DW100220MF	8	470 x 320 x 560
	DW100220MM	100mm DWV M&M Expansion Joint PVC. Allows approximately 220mm movement. Fitting measures 595mm open 375mm closed	EA	9349669000435	1	 9 349669 000435 DW100220MM	8	470 x 320 x 560
	DW100280	100mm DWV M&F Fabricated Extended Expansion Joint PVC. Allows approximately 280mm movement. Fitting measures 720mm open 440mm closed	EA	9349669000442	1	 9 349669 000442 DW100280	8	650 x 380 x 550
	DW100280T	100mm DWV M&F Fabricated Extended Expansion Joint Taped PVC. (Taped with Expanda Tape). Allows approximately 280mm movement Fitting measures 580mm	EA	9349669000459	1	 9 349669 000459 DW100280T	8	470 x 320 x 560
	DW10045150	100mm x 45° DWV F&F Fabricated Expansion Bend PVC. Allows approximately 150mm movement. Top to Invert 300mm	EA	9349669000466	1	 9 349669 000466 DW10045150	10	530 x 400 x 400
	DW10045230	100mm x 45° DWV F&F Fabricated Expansion Bend PVC. Allows approximately 230mm movement. Top to Invert 390mm long	EA	9349669000473	1	 9 349669 000473 DW10045230	8	530 x 400 x 400















*Note: For all Expansion and Swivel Joints - FF = Female socket to Female socket FM = Female socket to Male pipe size

MF = Male pipe size to Female socket

MM= Male pipe size to Male pipe size

Storm Plastics National Product Guide

Prices are nett and do not include GST

Product Photo	Product Code	Product Description	UOM	Barcaode #	EACH	Barcode	Carton Qty	Carton Dimensions
	DW10050FF	100mm DWV F&F Expansion Joint PVC. Allows approximately 50mm movement. Fitting measures 270mm open 220mm closed	EA	9349669000480	1	 9 349669 000480 DW10050FF	16	470 x 320 x 560
	DW10050FM	100mm DWV F&M Expansion Joint PVC. Allows approximately 50mm movement. Fitting measures 270mm open 220mm closed	EA	9349669000497	1	 9 349669 000497 DW10050FM	16	470 x 320 x 560
	DW10050MF	100mm DWV M&F Expansion Joint PVC. Allows approximately 50mm movement. Fitting measures 270mm open 220mm closed	EA	9349669000503	1	 9 349669 000503 DW10050MF	16	470 x 320 x 560
	DW10050MFT	100mm DWV M&F Short Taped Expansion Joint PVC (Taped with Expanda Tape). Allows approximately 50mm movement. Fitting measures 270mm open 220mm closed	EA	9349669000510	1	 9 349669 000510 DW10050MFT	20	470 x 320 x 560
	DW10050MM	100mm DWV M&M Expansion Joint PVC. Allows approximately 50mm movement. Fitting measures 270mm open 220mm closed	EA	9349669000527	1	 9 349669 000527 DW10050MM	16	470 x 320 x 560
	DW10090150	100mm x 90° DWV F&F Fabricated Expansion Bend PVC. Allows approximately 150mm movement. Top to Invert 330mm	EA	9349669000534	1	 9 349669 000534 DW10090150	10	530 x 400 x 400
	DW10090230	100mm x 90° DWV F&F Fabricated Expansion Bend PVC. Allows approximately 230mm movement. Top to Invert 420mm	EA	9349669000541	1	 9 349669 000541 DW10090230	8	470 x 320 x 560

*Note: For all Expansion and Swivel Joints - FF = Female socket to Female socket

FM = Female socket to Male pipe size

MF = Male pipe size to Female socket

MM= Male pipe size to Male pipe size

Storm Plastics National Product Guide

Prices are nett and do not include GST

Product Photo	Product Code	Product Description	UOM	Barcaode #	EACH	Barcode	Carton Qty	Carton Dimensions
	DW150240FF	150mm DWV F&F Fabricated Expansion/Repair Joint PVC. Allows approximately 240mm movement. Fitting measures 790mm open 550mm closed	EA	9349669001487	1	 9 349669 001487 DW150240FF	6	570 x 430 x 510
	DW150240MF	150mm DWV M&F Fabricated Expansion/Repair Joint PVC. Allows approximately 240mm movement. Fitting measures 790mm open 550mm closed	EA	9349669000558	1	 9 349669 000558 DW150240MF	6	570 x 430 x 510
	DW150240T	150mm DWV M&F Fabricated Expansion/Repair Joint Taped PVC. Allows approximately 240mm movement. Fitting measures 790mm open 550mm closed	EA	9349669001142	1	 9 349669 001142 DW150240T	6	570 x 430 x 510
	DW15045240	150mm x 45° DWV F&F Fabricated Expansion Bend PVC. Allows approximately 240mm movement. Top to Invert 470mm	EA	9349669000565	1	 9 349669 000565 DW15045240	2	650 x 380 x 550
	DW15090240	150mm x 90° DWV F&F Fabricated Expansion Bend PVC. Allows approximately 240mm movement. Top to Invert 520mm	EA	9349669000589	1	 9 349669 000589 DW15090240	2	650 x 380 x 550















*Note: For all Expansion and Swivel Joints - FF = Female socket to Female socket FM = Female socket to Male pipe size

MF = Male pipe size to Female socket

MM= Male pipe size to Male pipe size

Storm Plastics National Product Guide

Prices are nett and do not include GST

Product Photo	Product Code	Product Description	UOM	Barcaode #	EACH	Barcode	Carton Qty	Carton Dimensions
	DW4080	40mm DWV M&F Fabricated Expansion Repair Joint PVC. Allows approximately 80mm movement. Fitting measures 290mm open 210mm closed	EA	9349669000596	1	 9 349669 000596 DW4080	1	N/A
	DW50120	50mm DWV M&F Fabricated Expansion/Repair Joint PVC. Allows approximately 120mm movement. Fitting measures 380mm open 260mm closed	EA	9349669001111	1	 9 349669 001111 DW50120	1	N/A
	DW5080	50mm DWV M&F Fabricated Expansion/Repair Joint PVC. Allows approximately 80mm movement. Fitting measures 310mm open 230mm closed	EA	9349669000602	1	 9 349669 000602 DW5080	1	N/A
	DW50EXTEJ	50mm DWV M&F Fabricated Extended Expansion/Repair Joint PVC. Allows approximately 250mm movement. Fitting measures 640mm open 390mm closed	EA	9349669000619	1	 9 349669 000619 DW50EXTEJ	1	N/A
	DW50EXTEJ300	50mm DWV M&F Fabricated Extended Expansion/Repair Joint PVC. Allows approximately 300mm movement. Fitting measures 745mm open 445mm closed	EA	9349669001135	1	 9 349669 001135 DW50EXTEJ300	1	N/A
	DW65120	65mm DWV M&F Fabricated Expansion/Repair Joint PVC. Allows approximately 120mm movement. Fitting measures 395mm open 275mm closed	EA	9349669000626	1	 9 349669 000626 DW65120	1	N/A
	DW80150	80mm DWV M&F Fabricated Expansion/Repair Joint PVC. Allows approximately 150mm movement. Fitting measures 515mm open 365mm closed	EA	9349669000633	1	 9 349669 000633 DW80150	1	N/A

*Note: For all Expansion and Swivel Joints - FF = Female socket to Female socket FM = Female socket to Male pipe size

MF = Male pipe size to Female socket

MM= Male pipe size to Male pipe size

Storm Plastics National Product Guide

Prices are nett and do not include GST

Product Photo	Product Code	Product Description	UOM	Barcaode #	EACH	Barcode	Carton Qty	Carton Dimensions
	DWC225210	225mm DWV F&F Expansion Coupling PVC. Rubber ring one end, solvent weld joint on other end. Measures 390mm long. Allows approximately 210mm movement	EA	9349669000640	1	 9 349669 000640 DWC225210	1	N/A
	DWEJ225210	225mm DWV F&F Expansion Joint PVC. Allows approximately 210mm movement. Measures 750mm open 540mm closed	EA	9349669000657	1	 9 349669 000657 DWEJ225210	1	N/A
	DWER225345	225mm DWV F&F Expansion/Repair Joint PVC. Allows approximately 345mm movement. Fitting measures 1015mm open 670mm closed	EA	9349669000664	1	 9 349669 000664 DWER225345	1	N/A
	DWS225150	225mm DWV F&F Slip Coupling PVC. Rubber ring either end. Measures 270mm long. Allows approximately 150mm movement	EA	9349669000671	1	 9 349669 000671 DWS225150	1	N/A
	DWS300150	300mm DWV F&F Slip Coupling PVC. Rubber ring either end. Measures 240mm long. Allows approximately 150mm movement	EA	9349669000688	1	 9 349669 000688 DWS300150	1	N/A
	DWS375150	375mm DWV F&F Slip Coupling PVC. Rubber ring either end. Measures 240mm long. Allows approximately 150mm movement	EA	9349669000695	1	 9 349669 000695 DWS375150	1	N/A











*Note: For all Expansion and Swivel Joints - FF = Female socket to Female socket FM = Female socket to Male pipe size

MF = Male pipe size to Female socket

MM= Male pipe size to Male pipe size

Storm Plastics National Product Guide

Prices are nett and do not include GST

Product Photo	Product Code	Product Description	UOM	Barcaode #	EACH	Barcode	Carton Qty	Carton Dimensions
	DWSA150	150mm DWV Fabricated Slab Adaptor PVC. Fitting measures approximately 250mm.	EA	9349669000701	1	 9 349669 000701 DWSA150	1	N/A
	EL12512	Expanda Lube 125ml Lubricant particularly suitable for installation of rubber ring joints in stacks & drains	EA	9349669000718	1	 9 349669 000718 EL12512	1	N/A
	ET10440	Expanda Tape Pack (10 strips/pack). 440mm x 75mm Denso tape impregnated with copper sulphate crystals on clear plumbers joining tape	PK	9349669000725	1	 9 349669 000725 ET10440	1	N/A
	ET12440	Expanda Tape Pack (12 strips/pack). 440mm x 75mm Denso tape impregnated with copper sulphate crystals on clear plumbers joining tape	PK	9349669000732	1	 9 349669 000732 ET12440	1	N/A
	EXTEJ100	100mm DWV M&F Extended Expansion Joint PVC. Allows various lengths of movement up to 500mm. Made to order as per customer's requirements	EA	9349669000749	1	 9 349669 000749 EXTEJ100	1	N/A

*Note: For all Expansion and Swivel Joints - FF = Female socket to Female socket

FM = Female socket to Male pipe size

MF = Male pipe size to Female socket

MM= Male pipe size to Male pipe size

Storm Plastics National Product Guide

Prices are nett and do not include GST

Product Photo	Product Code	Product Description	UOM	Barcaode #	EACH	Barcode	Carton Qty	Carton Dimensions
	FF100	100mm Floor Flange	EA	9349669000756	1	 9 349669 000756 FF100	1	N/A
	FF40	40mm Floor Flange	EA	9349669000763	1	 9 349669 000763 FF40	1	N/A
	FF50	50mm Floor Flange PVC	EA	9349669000770	1	 9 349669 000770 FF50	1	N/A
	FF65	65mm Floor Flange PVC	EA	9349669000787	1	 9 349669 000787 FF65	1	N/A
	FF80	80mm Floor Flange PVC	EA	9349669000794	1	 9 349669 000794 FF80	1	N/A
	FRC225/30015045	225mm/300mm FRC Pipe x 150mm PVC Pipe x 45° Stormwater Saddle Junction	EA	9349669000800	1	 9 349669 000800 FRC225/30015045	1	N/A
	FRC225/30015090	225mm/300mm FRC Pipe x 150mm PVC Pipe x 90° Stormwater Saddle Junction	EA	9349669000817	1	 9 349669 000817 FRC225/30015090	1	N/A
	FRC225/30022590	225mm/300mm FRC Pipe x 225mm PVC Pipe x 90° Stormwater Saddle Junction	EA	9349669000824	1	 9 349669 000824 FRC225/30022590	1	N/A
	FRC300/37515090	300mm/375mm FRC Pipe x 150mm PVC Pipe x 90° Stormwater Saddle Junction	EA	9349669000831	1	 9 349669 000831 FRC300/37515090	1	N/A
	FRC375/45015045	375mm/450mm FRC Pipe x 150mm PVC Pipe x 45° Stormwater Saddle Junction	EA	9349669000848	1	 9 349669 000848 FRC375/45015045	1	N/A

















*Note: For all Expansion and Swivel Joints - FF = Female socket to Female socket FM = Female socket to Male pipe size

MF = Male pipe size to Female socket

MM= Male pipe size to Male pipe size

Storm Plastics National Product Guide

Prices are nett and do not include GST

Product Photo	Product Code	Product Description	UOM	Barcaode #	EACH	Barcode	Carton Qty	Carton Dimensions
	FRC375/45015090	375mm/450mm FRC Pipe x 150mm PVC Pipe x 90° Stormwater Saddle Junction	EA	9349669000855	1	 9 349669 000855 FRC375/45015090	1	N/A
	FRC375/45022545	375mm/450mm FRC Pipe x 225mm PVC Pipe x 45° Stormwater Saddle Junction	EA	9349669000862	1	 9 349669 000862 FRC375/45022545	1	N/A
	FRC525/60015045	525mm/600mm FRC Pipe x 150mm PVC Pipe x 45° Stormwater Saddle Junction	EA	9349669000879	1	 9 349669 000879 FRC525/60015045	1	N/A
	FRC525/60015090	525mm/600mm FRC Pipe x 150mm PVC Pipe x 90° Stormwater Saddle Junction	EA	9349669000886	1	 9 349669 000886 FRC525/60015090	1	N/A
	HB50PWFB	Houseboat 50mm Plug & Washer Filter Bucket with 3mm holes Manufactured to fit inside a standard 50mm Plug & Washer Sink & Shower Waste Outlet	EA	9349669000893	1	 9 349669 000893 HB50PWFB	1	N/A
	HBGSTUS100	Houseboat 100mm Grease/Solids Trap Under Sink complete with screw-on Lid PVC Solids Strainer Bucket with 4mm holes & threaded coupling on outlet for ease of removal for maintenance cleaning. Item Measures: 405mm x 215mm x 210mm Capacity: 1.75 litres	EA	9349669000909	1	 9 349669 000909 HBGSTUS100	1	N/A
	HBGSTUS150	Houseboat 150mm Grease/Solids Trap Under Sink complete with screw-on Lid PVC Solids Strainer Bucket with 4mm holes & threaded coupling on outlet for ease of removal for maintenance cleaning. Item Measures: 495mm x 310mm x 275mm Capacity: 4.5 litres	EA	9349669000916	1	 9 349669 000916 HBGSTUS150	1	N/A
	HBSilt Trap	Houseboat Shower & Basin Silt Trap 150mm available with Bolted or Screw Lid & 4mm hole bucket. Manufactured to customer's required height up to 500mm PVC	EA	9349669000923	1	 9 349669 000923 HBSilt Trap	1	N/A
	HBUSS40	Houseboat 40mm Under Sink Strainer with 3mm holes & screw on Cap for maintenance cleaning, PVC	EA	9349669000930	1	 9 349669 000930 HBUSS40	1	N/A
	HBUSS50	Houseboat 50mm Under Sink Strainer with 3mm holes & screw on Cap for maintenance cleaning, PVC	EA	9349669000947	1	 9 349669 000947 HBUSS50	1	N/A















*Note: For all Expansion and Swivel Joints - FF = Female socket to Female socket FM = Female socket to Male pipe size

MF = Male pipe size to Female socket

MM= Male pipe size to Male pipe size

Storm Plastics National Product Guide

Prices are nett and do not include GST

Product Photo	Product Code	Product Description	UOM	Barcaode #	EACH	Barcode	Carton Qty	Carton Dimensions
	L1502SS	150mm Silt Trap Lid 316 Stainless Steel 2mm Light Duty O/D 214mm	EA	9349669000954	1	 9 3 49669 000954 L1502SS	1	N/A
	L2252	225mm Silt Trap Lid 2mm Light Duty Galv O/D 273.5mm	EA	9349669000961	1	 9 3 49669 000961 L2252	1	N/A
	L2252SS	225mm Silt Trap Lid Stainless Steel 2mm Light Duty O/D 273.5mm	EA	9349669000978	1	 9 3 49669 000978 L2252SS	1	N/A
	L2256SS	225mm Silt Trap Lid 6mm thick Stainless Steel O/D 273.5mm	EA	9349669000985	1	 9 3 49669 000985 L2256SS	1	N/A
	LS22510	225mm Silt Trap Lid Spacer Galv O/D 273.5mm	EA	9349669000992	1	 9 3 49669 000992 LS22510	1	N/A
	NT50	Neutraliser Tank 50 Litre PVC Item measures 500mm x 400mm x 450mm	EA	9349669001005	1	 9 3 49669 001005 NT50	1	N/A
	PF80F	80mm Puddle Flange Female PVC Fits over 80mm DWV Pipe. Grate not included	EA	9349669001012	1	 9 3 49669 001012 PF80F	1	N/A
	PF80M	80mm Puddle Flange Male PVC Fits inside 80mm DWV Pipe. Grate not included	EA	9349669001029	1	 9 3 49669 001029 PF80M	1	N/A

*Note: For all Expansion and Swivel Joints - FF = Female socket to Female socket

FM = Female socket to Male pipe size

MF = Male pipe size to Female socket

MM= Male pipe size to Male pipe size

Storm Plastics National Product Guide

Prices are nett and do not include GST

Product Photo	Product Code	Product Description	UOM	Barcaode #	EACH	Barcode	Carton Qty	Carton Dimensions
	PLTRAPBO	Plaster Trap (under sink) with 50mm bottom outlet PVC. Capacity 24.5 Litre	EA	9349669001036	1	 9 349669 001036 PLTRAPBO	1	N/A
	PLTRAP-Lid	Lid to suit Plaster Trap PVC	EA	9349669001043	1	 9 349669 001043 PLTRAP-Lid	1	N/A
	PLTRAPSO	Plaster Trap (under sink) with 50mm side outlet PVC. Capacity 25.5 Litre	EA	9349669001050	1	 9 349669 001050 PLTRAPSO	1	N/A
	PLTRAPSOSL	Plaster Trap PVC with 50mm Side Outlet and Sealed Lid Measures 400mm x 250mm x 350mm Capacity 25.5 Litre	EA	9349669001104	1	 9 349669 001104 PLTRAPSOSL	1	530 x 400 x 350
	S150100	150mm x 100mm Silt Trap complete with Increment, Stainless Steel Lid & PVC Bucket with 2mm holes	EA	9349669001067	1	 9 349669 001067 S150100	1	470 x 320 x 560
	S150400	150mm x 400mm Silt Trap Increment PVC	EA	9349669001074	1	 9 349669 001074 S150400	1	N/A
	S160110HDPE	160mm x 110mm HDPE Silt Trap complete with Stainless Steel Lid & Bucket with 1.5mm holes	EA	9349669001081	1	 9 349669 001081 S160110HDPE	1	470 x 320 x 560













*Note: For all Expansion and Swivel Joints - FF = Female socket to Female socket FM = Female socket to Male pipe size

MF = Male pipe size to Female socket

MM= Male pipe size to Male pipe size

Storm Plastics National Product Guide

Prices are nett and do not include GST

Product Photo	Product Code	Product Description	UOM	Barcaode #	EACH	Barcode	Carton Qty	Carton Dimensions
	S160110VFDPE	160mm x 110mm HDPE Silt Trap for Vinyl Floor Complete with Stainless Steel Lid and Bucket with 1.5mm Holes	EA	9349669001432	1	 9 349669 001432 S160110VFDPE	1	N/A
	S225100	225mm x 100mm Silt Trap complete with Increment, Galv Lid & PVC Bucket with 2mm holes	EA	9349669001098	1	 9 349669 001098 S225100	1	470 x 320 x 560
	S225150	225mm x 150mm Silt Trap complete with Increment, Galv Lid & PVC 2mm hole bucket	EA	9349669001128	1	 9 349669 001128 S225150	1	650 x 380 x 550
	S225475	225mm x 475mm Silt Trap Increment PVC	EA	9349669000572	1	 9 349669 000572 S225475	1	N/A
	S250110HDPE	250mm x 110mm HDPE Silt Trap complete with Stainless Steel Lid & Bucket with 1.5mm holes	EA	9349669001166	1	 9 349669 001166 S250110HDPE	1	610 x 390 x 720
	S250110VFDPE	250mm x 110mm HDPE Silt Trap for Vinyl Floor Complete with Stainless Steel Lid and Bucket with 1.5mm Holes	EA	9349669001425	1	 9 349669 001425 S250110VFDPE	1	N/A



*Note: For all Expansion and Swivel Joints - FF = Female socket to Female socket FM = Female socket to Male pipe size

MF = Male pipe size to Female socket

MM= Male pipe size to Male pipe size

Storm Plastics National Product Guide

Prices are nett and do not include GST

Product Photo	Product Code	Product Description	UOM	Barcaode #	EACH	Barcode	Carton Qty	Carton Dimensions
	SB1500120	1500mm x 120mm Plastic Coated Steel Support Bracket to suspend drain under foundation. 6mm steel rod encased in PVC tubing	EA	9349669001173	1	 9 349669 001173 SB1500120	1	N/A
	SB1500175	1500mm x 175mm Plastic Coated Steel Support Bracket to suspend drain under foundation. 6mm steel rod encased in PVC tubing	EA	9349669001180	1	 9 349669 001180 SB1500175	1	N/A
	SB150075	1500mm x 75mm Plastic Coated Steel Support Bracket to suspend drain under foundation. 6mm steel rod encased in PVC tubing	EA	9349669001197	1	 9 349669 001197 SB150075	1	N/A
	SB750120	750mm x 120mm Plastic Coated Steel Support Bracket to suspend drain under foundation. 6mm steel rod encased in PVC tubing	EA	9349669001203	1	 9 349669 001203 SB750120	1	N/A
	SB750175	750mm x 175mm Plastic Coated Steel Support Bracket to suspend drain under foundation. 6mm steel rod encased in PVC tubing	EA	9349669001210	1	 9 349669 001210 SB750175	1	N/A
	SB75075	750mm x 75mm Plastic Coated Steel Support Bracket, to suspend drain under foundation. 6mm steel rod encased in PVC tubing	EA	9349669001227	1	 9 349669 001227 SB75075	1	N/A
	SHDPEINLET	Inlet added to HDPE Silt Trap Increment	EA	9349669001159	1	 9 349669 001159 SHDPEINLET	1	N/A
	SJ/EXTEJ100	100mm DWV F&F Swivel/Extended Expansion Joint PVC. Allows +/- 15° rotation one end and length of movement made to order as per customer's requirements up to 500mm	EA	9349669001234	1	 9 349669 001234 SJ/EXTEJ100	1	N/A











*Note: For all Expansion and Swivel Joints - FF = Female socket to Female socket FM = Female socket to Male pipe size

MF = Male pipe size to Female socket

MM= Male pipe size to Male pipe size

Storm Plastics National Product Guide

Prices are nett and do not include GST

Product Photo	Product Code	Product Description	UOM	Barcaode #	EACH	Barcode	Carton Qty	Carton Dimensions
	SJ10015	100mm DWV F&M Swivel Combo Expansion Joint PVC. Allows +/- 15° rotation & 50mm expansion. Fitting measures approximately 325mm open 275mm closed	EA	9349669001241	1	 9 349669 001241 SJ10015	12	470 x 320 x 560
	SJ100BendCombo	100mm x 90° DWV F&F Swivel Combo Double Expansion Bend PVC. Allows +/- 15° rotation & 100mm expansion. Fitting measures approximately 570mm open 470mm closed	EA	9349669001258	1	 9 349669 001258 SJ100BendCombo	10	650 x 380 x 550
	SJ100ExpComboFF	100mm DWV F&F Swivel Combo Double Expansion Joint PVC. Allows +/- 15° rotation. Allows approximately 100mm movement. Fitting measures 425mm open 325mm closed	EA	9349669001265	1	 9 349669 001265 SJ100ExpComboFF	8	530 x 400 x 400
	SJ100ExpComboFM	100mm DWV F&M Swivel Combo Double Expansion Joint PVC. Allows +/- 15° rotation & approximately 100mm movement. Fitting measures approximately 425mm open 325mm closed	EA	9349669001272	1	 9 349669 001272 SJ100ExpComboFM	8	530 x 400 x 400
	SJ15015	150mm DWV F&M Swivel Combo Expansion Joint PVC. Allows +/- 15° rotation & 60mm expansion. Fitting measures approximately 435mm open 375mm closed	EA	9349669001289	1	 9 349669 001289 SJ15015	6	470 x 320 x 560
	SJ15015FF	150mm DWV F&F Swivel Combo Expansion Joint PVC Allows +/- 15° rotation & 60mm expansion Measures 430mm open 370mm closed	EA	9349669001296	1	 9 349669 001296 SJ15015FF	6	570 x 430 x 510









*Note: For all Expansion and Swivel Joints - FF = Female socket to Female socket FM = Female socket to Male pipe size

MF = Male pipe size to Female socket

MM= Male pipe size to Male pipe size

Storm Plastics National Product Guide

Prices are nett and do not include GST

Product Photo	Product Code	Product Description	UOM	Barcaode #	EACH	Barcode	Carton Qty	Carton Dimensions
	SJ15015FFSCRR	150mm DWV F&F Swivel Combo Double Expansion Joint PVC. Solvent Cement Joint one end Rubber Ring Joint other end. Allows +/- 15° rotation & 60mm inlet expansion & 40mm outlet expansion. Measures 435mm open 375mm closed	EA	9349669001302	1	 9 349669 001302 SJ15015FFSCRR	6	570 x 430 x 510
	SJ22520	225mm DWV F&M Swivel Combo Expansion Joint PVC Allows +/- 20° rotation & 130mm expansion Measures approx. 650mm open & 520mm closed	EA	9349669001319	1	 9 349669 001319 SJ22520	1	470 x 320 x 560
	SJ4/EXTEJ100	100mm DWV F&M 4 Swivel/Extended Expansion Joint PVC. Allows +/- 30° rotation either end and length of movement made to order as per customer's requirements up to 500mm	EA	9349669001326	1	 9 349669 001326 SJ4/EXTEJ100	1	N/A
	SPVCINLET	Inlet added to PVC Silt Trap Increment	EA	9349669001395	1	 9 349669 001395 SPVCINLET	1	N/A

*Note: For all Expansion and Swivel Joints - FF = Female socket to Female socket











FM = Female socket to Male pipe size

MF = Male pipe size to Female socket

MM= Male pipe size to Male pipe size

Storm Plastics National Product Guide

Prices are nett and do not include GST

Product Photo	Product Code	Product Description	UOM	Barcaode #	EACH	Barcode	Carton Qty	Carton Dimensions
	ST10090	100mm x 90mm M&F Stormwater Reducer PVC (Pipe to pipe)	EA	9349669001333	1	 9 349669 001333 ST10090	200	560 x 330 x 460
	ST7590	Fine Fit Adaptor. 75mm Galv/90mm PVC Stormwater Downpipe Adaptor. No crimping of Galv Downpipe necessary	EA	9349669001340	1	 9 349669 001340 ST7590	210	560 x 330 x 460
	ST9090	90mm M&F Stormwater Expanda Joint PVC. Allows approximately 90mm movement. Fitting measures 290mm open 200mm closed	EA	9349669001357	1	 9 349669 001357 ST9090	30	560 x 330 x 460
	STSJ10010090	Stormwater Saddle Junction 100mm x 100mm x 90° PVC Pipe	EA	9349669001364	1	 9 349669 001364 STSJ10010090	1	N/A
	STSJ15010090	Stormwater Saddle Junction 150mm x 100mm x 90° PVC Pipe	EA	9349669001371	1	 9 349669 001371 STSJ15010090	1	N/A
	STSJ22510090	Stormwater Saddle Junction 225mm x 100mm x 90° PVC Pipe	EA	9349669001388	1	 9 349669 001388 STSJ22510090	1	N/A

*Note: For all Expansion and Swivel Joints - FF = Female socket to Female socket

FM = Female socket to Male pipe size

MF = Male pipe size to Female socket

MM= Male pipe size to Male pipe size